

Article number: 50300503

Description: Closed pillow block PMC 50 E
FM standard bearing included

Measures

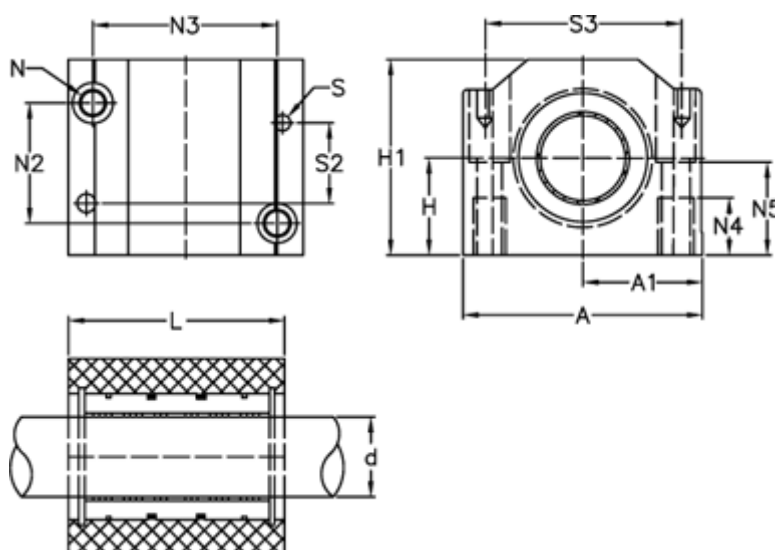

A = 132	N4 = 34
A1 = 66	N5 = 49
H = 50	S = 10
H1 = 105	S2 = 42
L = 113	S3 = 108
N = M16 x 2,0	Static load (kg) = 5250
N2 = 50.2	Weight (kg) = 3.169
N3 = 108.2	